

CONTENTS

	Page
Receiving Procedures.	1
Warranty.	1
Safety Information.	1 - 2
Machine Description.	3 - 4
Installation Instructions.	4
Operating Instructions.	5 - 7
Maintenance.	7

Operator's Manual

for Morse

**< PILOT > Power-Propelled Drum Racker
Model 910**

Serial Number 294521 to 417866



Receiving Procedures

Every Morse drum handler is inspected prior to shipping. However, damage may be incurred during transit.

- Check for visible damage. If you choose to accept damaged freight, always sign noting the damage on the **Bill of Lading**.
- Document the damage and have the truck driver sign. We recommend keeping a digital camera at your receiving dock for this purpose.
- Open packages expeditiously to check the condition of the goods. There is only a 24 hour window to notify the carrier of any concealed damage.
- Immediately **report all damage to the shipping company!** Then you may contact Morse for assistance with your freight claim.
- Morse Manufacturing will not be held responsible for any damaged freight that is not signed for as damaged.

Limited 2 Year Warranty

Morse drum handling equipment is guaranteed against defects in workmanship or materials for two years when used properly within its rated capacity. Warranty does not cover wear from normal use or damage from accident or abuse. Motors and other purchased parts carry the warranties of their manufacturers.

For warranty claims, contact your Morse Dealer to obtain a return authorization number, and for return freight advice. Return freight must be prepaid.

In all instances, liability is limited to the purchase price paid or to repairing or replacing the product. Customer assumes liability for any modifications, unauthorized repairs or parts substitution.

Safety Information

While Morse Manufacturing Co. drum handling equipment is engineered for safety and efficiency, a high degree of responsibility must be placed upon the machine operator to follow safe practices, based primarily on common sense, upon which true safety depends.

Failure to follow the safety precautions in this manual can result in personal injury or property damage. Observe the same precautions as with similar machinery where carelessness in operating or maintenance is hazardous to personnel. Carefully read the safety precautions below and throughout this manual.

Review the Material Safety Data Sheet(s) for the material(s) in the drum(s) and take all necessary precautions. Safety shoes, work gloves, hard hat and other personal protective devices are recommended.

Prior to initial use, inspect all moving parts and test rotation of drum holder. Perform necessary load test, inspections, operator training, etc.











Operator's Manual for Morse < PILOT > Power-Propelled Drum Racker Model 910
Serial Number 294521 to 417866

Safety Information (continued)

 **DANGER** - Indicates a situation which, if not avoided, *will* result in serious injury or death. This signal word is limited to the most extreme situations.

 **WARNING** - Indicates a situation which, if not avoided, *could* result in serious injury or death.

 **CAUTION** - Indicates a situation which, if not avoided, can result in damage to the machine.

-   **CAUTION - Do NOT transport with drum raised.**
Always lower the drum holder to lowest position before transporting.
-  **DANGER - Stay well clear of power lines.**
Never approach a power line. Current in a high voltage line may arc some distance from the wire to the steel framed, grounded machine.
-  **WARNING** - The < PILOT > Power-Propelled Drum Racker is designed to handle one drum of the types listed at the top of page 3 - Machine Description. DO NOT attempt to handle any other type of drum or object. DO NOT exceed the weight capacity.
-  **WARNING - Level floors only.**
For operation only on clean, level floors of suitable bearing capacity. Do not use on sloped surfaces, ramps, irregular or debris strewn floors.
-  **WARNING - Do NOT modify the unit.**
Under no circumstances should any modifications be made to the Morse machinery without factory authorization. Any modifications may void the warranty. This machine was designed to perform a specific job and alterations may result in injury to operator or machine.
-  **WARNING - No loose fitting clothing.**
Wear close-fitting clothing and safety equipment appropriate to the job. Loose fitting clothing may become caught on the machinery and cause severe personal injury.
-  **WARNING - Hydraulic fluid under pressure can be hazardous.**
Escaping hydraulic fluid under pressure can penetrate the skin, causing serious injury. Avoid the hazard by relieving pressure before disconnecting hydraulic lines. Keep hands and body away from pinholes and nozzles, which eject fluid under high pressure. Use a piece of cardboard to search for leaks. If an accident occurs, see a doctor immediately and inform them of the nature of the accident.
-  **CAUTION - Wear safety shoes.**
Wear safety shoes with non-slip soles and hard toe protection.
-  **WARNING:** This product can expose you to chemicals including barium sulfate, cobalt, titanium dioxide, and 2-methylimidazole, which are known to the State of California to cause cancer, and bisphenol-A, which is known to the State of California to cause birth defects or other reproductive harm.
For more information go to www.P65Warnings.ca.gov
-  **WARNING:** This product can expose you to chemicals including lead and arsenic, which are known to the State of California to cause cancer and birth defects or other reproductive harm.
For more information go to www.P65Warnings.ca.gov

**Operator's Manual for Morse < PILOT > Power-Propelled Drum Racker Model 910
Serial Number 294521 to 417866**

Machine Description

The Model 910 < PILOT > Power-Propelled Drum Racker will rack a drum at up to 10.5' (3.2 m) high, measured from the floor to the lowest point of a horizontal drum. It is designed to lift and/or place a 55-gallon (208 liter) steel or plastic drum with a suitable top lifting rim, in the vertical or horizontal position. The maximum capacity is 800 Lb. (363 kg).



Controls

Steering Arm and Control Handle (Figure 3.1)

The steering arm and control handle provide controls for steering, forward and reverse speed control, braking, and horn. The control handle has push buttons for raising and lowering the drum. Control handle also has a "belly-button" reversing switch which reverses the direction of the truck upon contact with the operator.

Forward and Reverse Travel Speed Control (Figure 3.1)

Forward and reverse are controlled by rotating the speed control lever. Further rotation in either direction will progress the truck from slow to maximum travel speed. The lever is spring loaded to return to neutral when released.

To reverse directions or to stop the truck, rotate the speed control lever in the opposite direction. The truck will come to a stop and then, unless the controls are returned to the center neutral position, accelerate in the opposite direction.



Figure 3.1

Steering (Figure 3.1)

Using the control handle to move the steering arm to left or right will turn the truck left or right. When maneuvering around corners, make square turns and be sure there is adequate clearance.

Stopping (Figure 3.2)

Stop the truck as gradually as possible. Unnecessary rapid stopping could be hazardous. Load could become unstable.

There are four possible ways to stop the truck:

1. **Plugging:** This electrical braking function consists of rotating the speed control lever in opposite direction of travel and then releasing it when the truck stops. Plugging is a convenient way to stop the truck during normal operation. If the control is not released, the truck will accelerate in the opposite direction.
2. **Steering arm in horizontal position:** Lowering the steering arm to the horizontal position applies the brakes. Lowering the steering arm below horizontal position increases the braking force and de-energizes the controls.
3. **Steering arm in vertical position:** Raising the steering arm to near vertical position applies the brakes. Further vertical positioning increases the braking force and de-energizes the controls. This position serves as a parking brake.
4. **Deadman braking:** As a safety precaution, the steering arm is spring loaded to return to the vertical position and apply the brakes if the driver releases the control handle during operation. This is known as deadman braking.

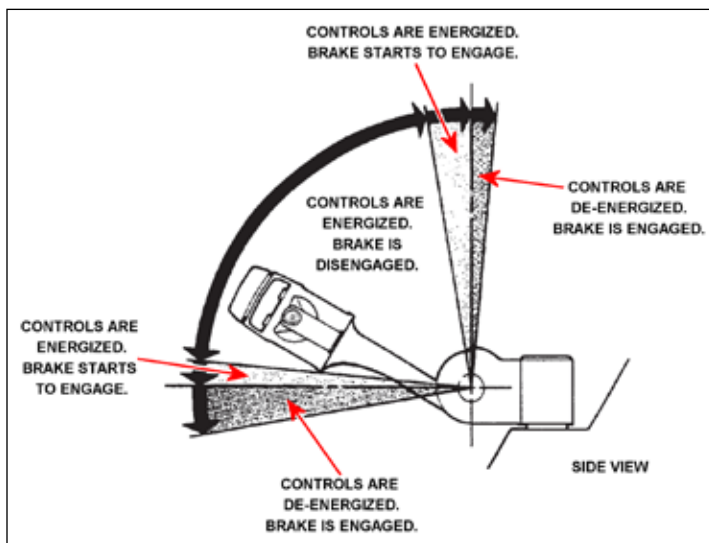

Figure 3.2

Operator's Manual for Morse < PILOT > Power-Propelled Drum Racker Model 910 Serial Number 294521 to 417866

Lift / Lower and Tilt Control Levers (Figure 4.1)

- The LIFT CONTROL LEVER, used to lift and lower a drum, is mounted near the base of the steering arm. Push lever away from operator to lift a drum, and pull lever toward you to lower a drum.
- The TILT CONTROL LEVER is also mounted near the base of the steering arm. Push lever away from you to tilt the drum to vertical, and pull this lever toward the operator to tilt the drum to horizontal.

Battery Disconnect (Figure 4.1)

A battery disconnect is mounted near the rear of the battery compartment. Pulling the disconnect removes all power from truck circuits in the event of an emergency.

Parking

When parking the truck, do not obstruct traffic lanes or aisles.

1. Park the truck in its designated parking area.
2. Raise the steering arm until vertical to apply the parking brake.
3. Fully lower lift assembly.
4. Turn key to off position. Remove key for added security.
5. Pull out battery disconnect.

Also see [further information](#).



Figure 4.1



WARNING - Watch out for pinch points

Stay clear of moving parts. Operator should remain behind the controls during the lift operation.

**Operator's Manual for Morse < PILOT > Power-Propelled Drum Racker Model 910
Serial Number 294521 to 417866**

Operating Instructions

To lift an upright drum from the floor and place horizontally in a drum rack:

1. Tilt the drum holder assembly down to the vertical position by pulling the TILT CONTROL LEVER toward the operator. Rotate the grip pad hand wheel counter-clockwise to the full OPEN position.
2. Using the LIFT CONTROL LEVER, position the drum holder assembly with the top rim grip pads several inches above the drum (see Figure 5.1).
3. Move the < PILOT > toward the drum, until the two parallel drum-supporting bars are firmly resting against the side of the drum.
4. Lower the drum holder assembly until the bridge meets the top of the drum. In this position, the top rim grip pads should be an inch or two below the top drum rim.
5. Rotate the grip pad hand wheel clockwise to close the grip pads tightly on the drum. Ensure that the chime catches on the two parallel drum-supporting bars are immediately under the top rim of the drum.
6. Visually inspect the drum holder assembly and position of the drum to verify proper engagement of the grip pads and chime catches. With the grip pads and chime catches secure, push the LIFT CONTROL LEVER to raise the drum. Continue to raise only until the drum is 6"-12" clear of the floor, a height sufficient to permit the drum to swing clear of the floor when tilting to horizontal.



WARNING - Stay clear of raised drum.
NEVER allow anyone to be below any part of a raised drum handler or drum.
Remain behind the control handle while handling a drum.

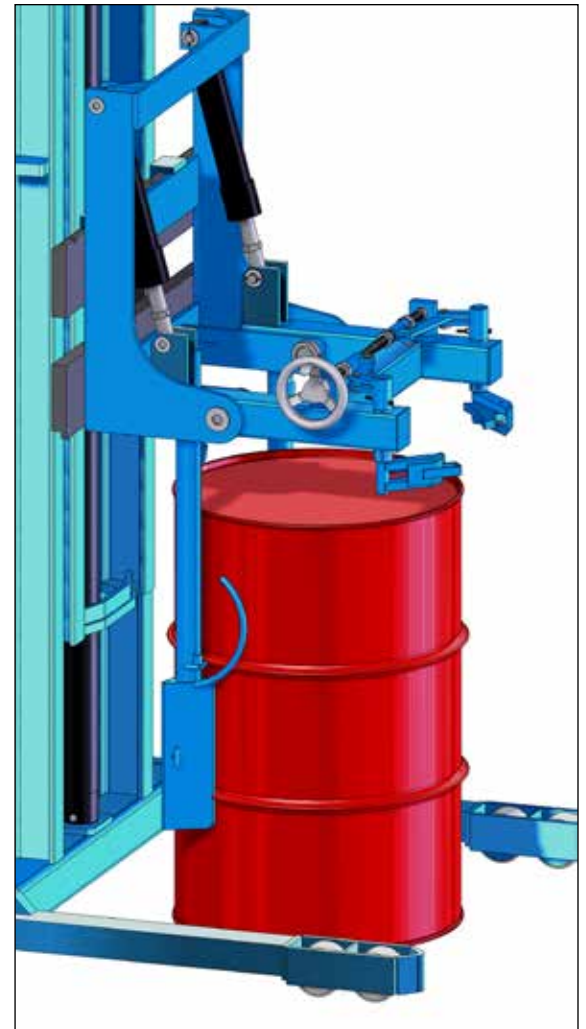

Figure 5.1

7. After ensuring that the area in front of the < PILOT > is clear, tilt the drum to the horizontal position by pushing TILT CONTROL LEVER. Do not raise the drum until you have reached the racking area. It can be unsafe to move the < PILOT > with a raised drum.
8. After the drum has been tilted to the horizontal position, rotate the grip pad hand wheel counter-clockwise to the full open position. This will allow the drum to be cradled by the two parallel drum-supporting bars and allow it to be racked horizontally.

Note: There are interlock switches built into the drum holder which are intended to prevent tilting when the drum is not properly positioned. If the grip pad or the top drum rim is not properly positioned, *the tilting function is disabled.*

9. Move the < PILOT > to the drum storage area and raise or lower the drum to a height that is a couple of inches higher than the shelf height. Push the unit into the storage position and carefully lower the drum onto the rack. The two parallel drum-support bars should be just below the walls of the drum but still above the rack. This will allow clearance to withdraw the < PILOT > and leave the drum in the storage position.

**Operator's Manual for Morse < PILOT > Power-Propelled Drum Racker Model 910
Serial Number 294521 to 417866**

To take a horizontal drum from a rack and place upright on the floor:

1. Tilt the drum holder assembly to the horizontal position and rotate the grip pad hand wheel counter-clockwise to the full open position. Raise the drum holder assembly to the approximate elevation of the drum to be taken down. Move the < PILOT > up to the drum and adjust the height of the drum grab, if necessary, to clear the drum walls and rack.
2. Move the < PILOT > forward until the "bridge" meets the head of the drum. (see Figure 5.1).

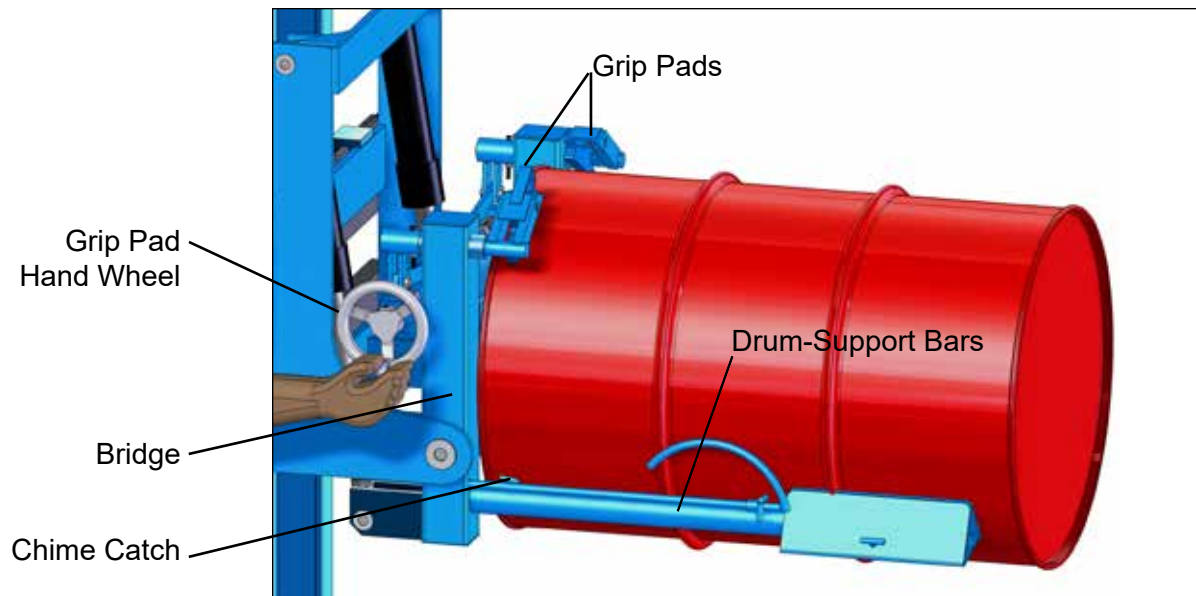

Figure 5.1



DANGER - IT IS CRITICAL THAT THE BRIDGE OF THE DRUM HOLDER ASSEMBLY IS FULLY PRESSED AGAINST THE TOP OF THE DRUM BEFORE LIFTING FROM THE HORIZONTAL position. IF THE TOP OF THE DRUM IS NOT SEATED AGAINST THE BRIDGE, THE RIM GRIP PADS MAY NOT PROPERLY ENGAGE AND THE DRUM CAN SLIDE OFF.

Note: There are interlock switches built into the drum holder which are intended to prevent tilting when the drum is not properly positioned. The true safety of this operation, however, depends on the operator correctly positioning the drum in the drum holder, and verifying proper engagement of the rim grip pads.

3. Raise the horizontal drum from the rack a few inches and back the < PILOT > away. Lower the horizontal drum to about 48" from the floor. Rotate the grip pad hand wheel clockwise to close the grip pads tightly on the drum.



WARNING - DO NOT tilt the horizontal drum down if it is less than 48" off the floor. The drum and / or drum holder can interfere with the floor when tilting.

4. Carefully tilt the drum down to the vertical position.
5. Lower the upright drum to the floor and when the weight of the drum is entirely on the floor, rotate the grip pad hand wheel counter-clockwise to the full open position.

Operator's Manual for Morse < PILOT > Power-Propelled Drum Racker Model 910
Serial Number 294521 to 417866



WARNING – When the drum is in the upright position, lower the drum to the floor before releasing.

6. Raise the drum holder assembly about 12", until the rim grip pads are clearly above the top of the drum. Move the < PILOT > back to clear the drum.

Maintenance

1. Periodic inspection for the general condition of structural and mechanical components is imperative for safe and efficient operation.
2. Periodically inspect all moving parts, framework, drum holder and contact areas for signs of wear, fatigue, or loosening. Tighten, adjust, or replace parts as necessary to prevent failure and maintain proper function.
3. Inspect the hydraulic system for oil drips, hose damage, or other signs of wear. Replace any parts that show signs of wear.
4. Oil or grease all moving parts.
5. Worn or damaged parts must be properly replaced with the correct, genuine Morse parts.

Also see more detailed [maintenance intructions](#).