

CONTENTS

- Receiving Procedures
- Warranty
- Safety Information
- Machine Description
- Assembly Instructions
- Operating Instructions
- Maintenance
- Parts List and Diagram

Receiving Procedures

Every Morse drum handler is inspected prior to shipping. However, damage may be incurred during transit.

- Check for visible damage. If you choose to accept damaged freight, always sign noting the damage on the **BILL OF LADING**.
- Document the damage and have the truck driver sign. We recommend keeping a digital camera at your receiving dock for this purpose.
- Open packages expeditiously to check the condition of the goods. There is only a 24 hour window to notify the carrier of any concealed damage.
- **IMMEDIATELY REPORT ALL DAMAGE TO THE SHIPPING COMPANY!** Then you may contact Morse for assistance with your freight claim.
- Morse Manufacturing will not be held responsible for any damaged freight that is not signed for as damaged.

Delivery to non-business addresses without a loading dock result in additional freight charges. Residential delivery fees, inside delivery fees, re-delivery charges, and lift gate services will be added by the truck line, and are non-negotiable.

Limited 2 Year Warranty

Morse drum handling equipment is guaranteed against defects in workmanship or materials for **TWO YEARS** when used properly within its rated capacity. Warranty does not cover wear from normal use or



damage from accident or abuse. Motors and other purchased parts carry the warranties of their manufacturers.

For warranty claims, contact your Morse Dealer to obtain a return authorization number, and for return freight advice. Return freight must be prepaid.

In all instances, liability is limited to the purchase price paid or to repairing or replacing the product. Customer assumes liability for any modifications, unauthorized repairs or parts substitution.

Safety Information

While Morse Manufacturing Co. drum handling equipment is engineered for safety and efficiency, a high degree of responsibility must be placed upon the machine operator to follow safe practices, based primarily on common sense, upon which true safety depends.

Failure to follow the safety precautions in this manual can result in personal injury or property damage. Observe the same precautions as with similar machinery where carelessness in operating or maintenance is hazardous to personnel. Carefully read the safety precautions below and throughout this manual.















DANGER - Indicates a situation which, if not avoided, *will* result in serious injury or death. This signal word is limited to the most extreme situations.



WARNING - Indicates a situation which, if not avoided, *could* result in serious injury or death.



CAUTION - Indicates a situation which, if not avoided, can result in damage to the machine.

	WARNING - Drum Lifter is designed to handle one drum of the types listed at the top of page 3. Machine Description. DO NOT attempt to handle any other type of drum or object.
	WARNING - DO NOT exceed the weight capacity of 1000 Lb. (454 kg).
	WARNING - DO NOT operate damaged or malfunctioning unit, or a unit with missing parts.
	WARNING - DO NOT lift people or suspend loads over people. Stay clear of suspended loads.
	WARNING - DO NOT lift loads higher than necessary.
	WARNING - DO NOT leave suspended loads unattended.
	CAUTION - DO NOT remove or obscure warning labels.
	WARNING - DO NOT operate without first having read and understood operating manual.
	WARNING - DO NOT make alterations or modify the unit. Under no circumstances should any modifications be made to the Morse machinery without factory authorization. Any modifications may void the warranty. This machine was designed to perform a specific job and alterations may result in injury to operator or machine.
	WARNING - Wear safety shoes with non-slip soles and hard toe protection.
	CAUTION - DO NOT allow drum to impact on floor, ground, etc.
	WARNING - This product can expose you to chemicals including barium sulfate, cobalt, titanium dioxide, and 2-methylimidazole, which are known to the State of California to cause cancer, and bisphenol-A, which is known to the State of California to cause birth defects or other reproductive harm. For more information go to www.P65Warnings.ca.gov

Machine Description

Model 86 Drum Lifter is designed to lift and transport a 55-gallon (210 liter) steel, plastic or fiber drum 22" to 23.5" (56 to 59.7 cm) in diameter and 23" to 38" (58.4 to 96.5 cm) tall. The maximum capacity is 1000 Lb. (454 kg).



Accessories

A smaller diameter drum can be handled with the correct size 55/30 Series Diameter Adapter installed.

See Diameter Adapter info at:

<https://morsedrum.com/products/diameter-adapters>

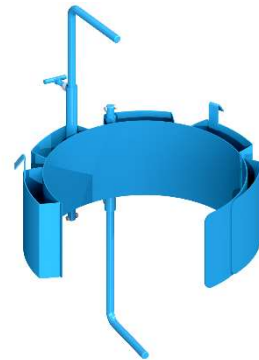

Important

1. Review Material Safety Data Sheet(s) for material(s) in drum(s) and take all necessary precautions. Safety shoes, work gloves, hard hat and other personal protective devices are recommended.
2. Please read all instructions thoroughly before attempting to operate your new MORSE drum handler.
3. Model 86 has maximum capacity rating of 1000 Lb. (454 kg) and is designed to lift and move drums of size and type noted above. DO NOT exceed this load rating. Exceeding this rating or handling drums other than those mentioned above is unsafe and could result in equipment damage, excessive wear or awkward handling.
4. When loading, unloading, operating, or maintaining your Morse drum handler, always use care and good judgment, have good footing and firm hold. Keep hands and loose clothing, etc. away from all moving parts. Never allow anyone to be below any part of a raised drum handler or drum. Read operating instructions and review pictures in sales brochure before operation.
5. Model 86 is a "Group 1 Structural and Mechanical" Below-the-Hook Lifting Device which is covered by the American National Standard ASME B30.20. The user should comply with all aspects of this standard. Unit has been factory load tested and furnished with load test certificate.

Assembly Instructions

1. Remove TOP carriage bolt and lock nut on each side. Loosen bottom lock nut one turn.
2. Swing frame weldment to vertical position and replace top carriage bolt and lock nut. Tighten all four lock nuts to 47 ft-lb (64 N-m).
3. Prior to use, inspect all moving parts. Inspect web strap and ratchet assembly for proper operation. Perform necessary load test, inspections, operator training, etc. as prescribed in the ASME B30.20 standard.



Operating Instructions

1. With the model 86 on the floor, lower hoist and engage hoist hook into the lifting eye.
2. Raise hoist to lift the 86 clear of the floor and move it to the drum.
3. Position the 86 with the base at floor level and near or against the base of drum.
4. Using a drum hand truck (e.g. Morse Model 160), carefully place the drum onto the base of the 86 so that the drum rests into the saddle band.
5. Drape the web strap across the face of the drum and engage into slot on the ratchet and tighten the web strap around the drum by turning the ratchet handle.
6. Raise hoist and move drum to desired location.

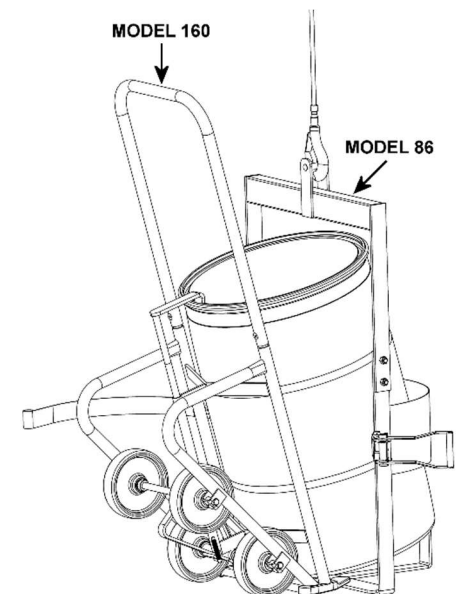

To remove drum

1. Lower drum to floor
2. Squeeze the ratchet release lever and open all the way to unlock. Then release the tension on the strap. Allow enough slack in the strap in order to remove strap from ratchet.
3. Remove the drum from the 86-SS using a drum truck.

Maintenance

1. Periodically inspect all moving parts, framework, and contact areas for signs of wear, fatigue, or loosening.
2. Tighten, adjust or replace parts as necessary to prevent failure and maintain proper function. The web strap should be removed from service or replaced if any of the following are visible:
 - Acid or caustic burns
 - Melting or charring of any part of the strap
 - Holes, tears, cuts, snags or embedded articles
 - Broken or worn stitching in load bearing splices
 - Excessive abrasive wear
3. Perform all inspections, load tests, and maintenance according to the ANSI/ASME B30.20 standard.

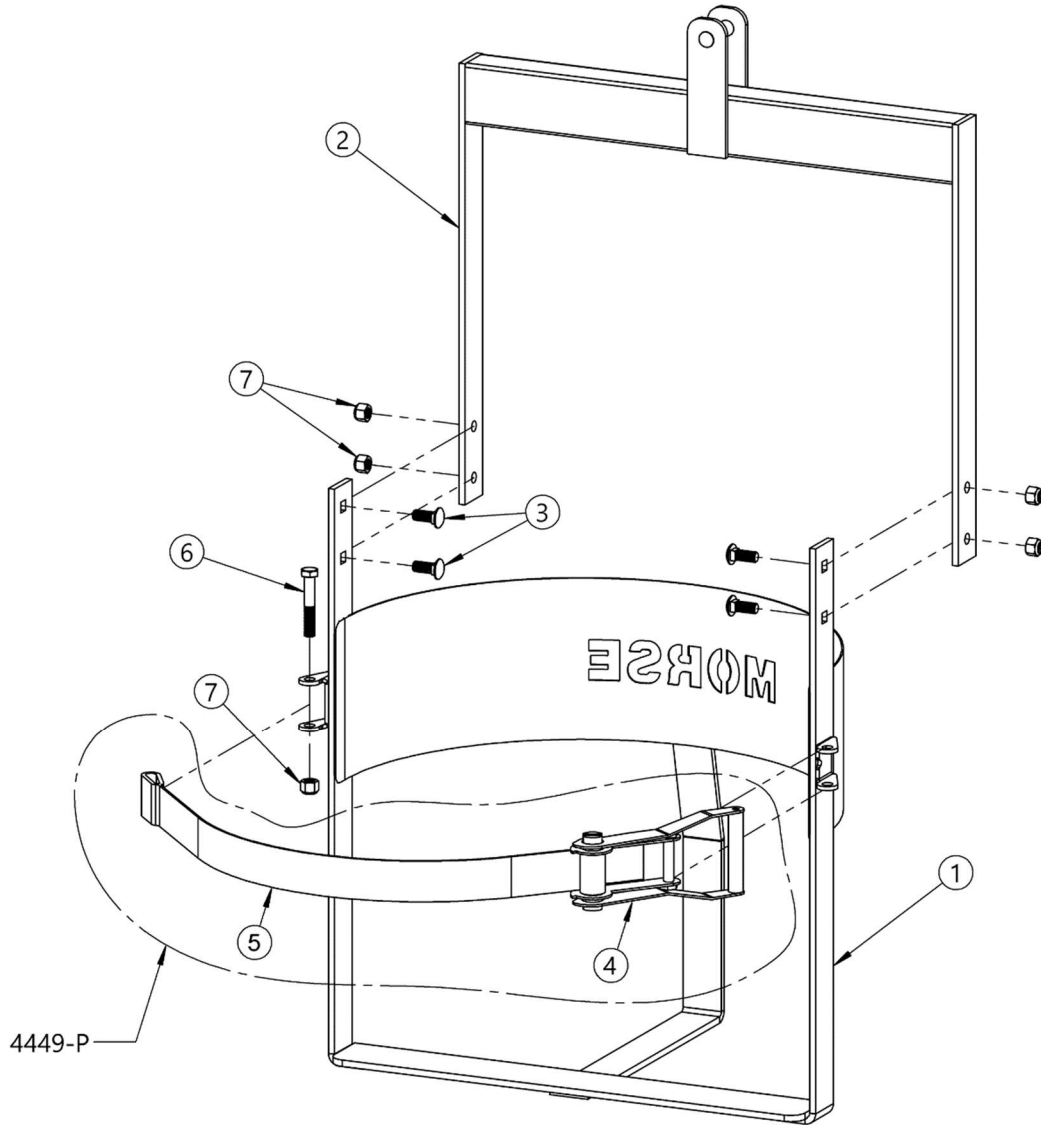

ITEM NO.	PART NUMBER	DESCRIPTION	QTY.
1	6264-P	BOTTOM SECTION, KD 86, STRAP	1
2	3668-P	TOP SECTION, KD 86	1
3	805-P	BOLT, 1/2-13 X 1-1/4 CARRIAGE	4
4	5498-P	RATCHET ONLY, 4449-P	1
5	5497-P	WEB STRAP, POLYESTER, 4449-P	1
6	6272-P	HHCS, 1/2-13 X 3-1/4"	1
7	6266-P	NUT, 1/2-13 NYLON LOCK	5