

CONTENTS

- Receiving Procedures
- Warranty
- Safety Information
- Machine Description
- Operating Instructions
- Maintenance
- Parts Diagram
- Dimensions

Receiving Procedures

Every Morse drum handler is inspected prior to shipping. However, damage may be incurred during transit.

- Check for visible damage. If you choose to accept damaged freight, always sign noting the damage on the **BILL OF LADING**.
- Document the damage and have the truck driver sign. We recommend keeping a digital camera at your receiving dock for this purpose.
- Open packages expeditiously to check the condition of the goods. There is only a 24 hour window to notify the carrier of any concealed damage.
- **IMMEDIATELY REPORT ALL DAMAGE TO THE SHIPPING COMPANY!** Then you may contact Morse for assistance with your freight claim.
- Morse Manufacturing will not be held responsible for any damaged freight that is not signed for as damaged.

Delivery to non-business addresses without a loading dock result in additional freight charges. Residential delivery fees, inside delivery fees, re-delivery charges, and lift gate services will be added by the truck line, and are non-negotiable.

Limited 2 Year Warranty

Morse drum handling equipment is guaranteed against defects in workmanship or materials for **TWO YEARS** when used properly within



its rated capacity. Warranty does not cover wear from normal use or damage from accident or abuse. Motors and other purchased parts carry the warranties of their manufacturers.

For warranty claims, contact your Morse Dealer to obtain a return authorization number, and for return freight advice. Return freight must be prepaid.

In all instances, liability is limited to the purchase price paid or to repairing or replacing the product. Customer assumes liability for any modifications, unauthorized repairs or parts substitution.

Safety Information

While Morse Manufacturing Co. drum handling equipment is engineered for safety and efficiency, a high degree of responsibility must be placed upon the machine operator to follow safe practices, based primarily on common sense, upon which true safety depends.

Failure to follow the safety precautions in this manual can result in personal injury or property damage. Observe the same precautions as with similar machinery where carelessness in operating or maintenance is hazardous to personnel. Carefully read the safety precautions below and throughout this manual.

Review the Material Safety Data Sheet(s) for the material(s) in the drum(s) and take all necessary precautions. Safety shoes, work gloves, hard hat and other personal protective devices are recommended.

Prior to initial use, inspect all moving parts. Perform necessary load test, inspections, operator training, etc.















DANGER - Indicates a situation which, if not avoided, *will* result in serious injury or death. This signal word is limited to the most extreme situations.



WARNING - Indicates a situation which, if not avoided, *could* result in serious injury or death.



CAUTION - Indicates a situation which, if not avoided, can result in damage to the machine.

	WARNING - Drum Lifter is designed to handle one drum of the types listed in Machine Description. DO NOT attempt to handle any other type of drum or object.
	WARNING - DO NOT use with a drum which has no top. Drum top is necessary to make drum sufficiently rigid for proper lifting.
	WARNING - DO NOT exceed the weight capacity of 1000 Lb. (454 kg).
	WARNING - DO NOT operate damaged or malfunctioning unit, or a unit with missing parts.
	WARNING - DO NOT lift people or suspend loads over people. Stay clear of suspended loads.
	WARNING - DO NOT lift loads higher than necessary.
	WARNING - Do NOT leave suspended loads unattended.
	WARNING - DO NOT remove or obscure warning labels.
	WARNING - DO NOT operate without first having read and understood operating manual.
	WARNING - DO NOT make alterations or modify the unit. Under no circumstances should any modifications be made to the Morse machinery without factory authorization. Any modifications may void the warranty. This machine was designed to perform a specific job and alterations may result in injury to operator or machine.
	WARNING - Wear safety shoes with non-slip soles and hard toe protection.
	CAUTION - DO NOT allow drum to impact on floor, ground, etc.
	WARNING - This product can expose you to chemicals including barium sulfate, cobalt, titanium dioxide, and 2-methylimidazole, which are known to the State of California to cause cancer, and bisphenol-A, which is known to the State of California to cause birth defects or other reproductive harm. For more information go to www.P65Warnings.ca.gov

Machine Description

Model 91 Drum Lifter is designed to lift and transport a standard 55-gallon (210 liter) steel drum 22.5" (57 cm) in diameter as well as an 85-gallon (322 liter) overpack or salvage drum 26" in diameter. The maximum capacity is 1000 Lb. (454 kg).



Drums may be "tight head" type with head intact, or removable top with lid securely clamped in place.

Important

1. Review the Material Safety Data Sheet(s) for the material(s) in the drum(s) and take all necessary precautions. Safety shoes, work gloves, hard hat and other personal protective devices are recommended.
2. Please read all instructions thoroughly before attempting to operate your new Morse drum handler.
3. Model 91 Drum Lifter has maximum capacity rating of 1000 Lb. (454 kg) and is designed to lift and move a closed drum of the size and type noted above. DO NOT exceed this rating. Exceeding this rating or handling drums other than those mentioned above is unsafe and could result in equipment damage, excessive wear, awkward or dangerous handling.
4. When loading, unloading, operating, or maintaining your MORSE drum handler, always use care and good judgment. Maintain secure footing and a firm hold. Keep hands and loose clothing away from all moving parts. Never allow anyone to be below any part of a raised drum handler or drum. Read operating instructions and review the pictures in the sales brochure before operation.
5. Model 91 is a "Group 1 structural and mechanical" below-the-hook lifting device which are covered by the American National Standard ASME B30.20. The user should comply with all aspects of this standard. Unit has been factory load tested and furnished with a load test certificate.

Operating Instructions

1. Start with Drum Lifter on the floor resting on its gripping shoes.
2. Lower hoist hook to reach the lifting eye. Engage hoist hook to lifting eye.
3. Raise hoist to lift Drum Lifter off the floor.
4. Move hoist with "open" Drum Lifter over the drum and lower it. Hoist should be guided so that Drum Lifter settles across the center of the drum top.
5. Place a gripping shoe below the drum rim. Swing other gripping shoe toward the drum until it engages below the drum rim.
6. Raise hoist to lift the drum. You may move the drum as necessary by moving the hoist.
7. To place the drum, simply lower the hoist. Continue to lower hoist so that the Drum Lifter may be removed.
8. Raise the hoist to lift the Drum Lifter clear of the drum.

Maintenance

1. Oil pivot pin so that arm will swing freely.
2. Periodically inspect all moving parts, framework and contact areas for signs of wear, fatigue or loosening. Tighten, adjust or replace parts as necessary to prevent failure and maintain proper function.

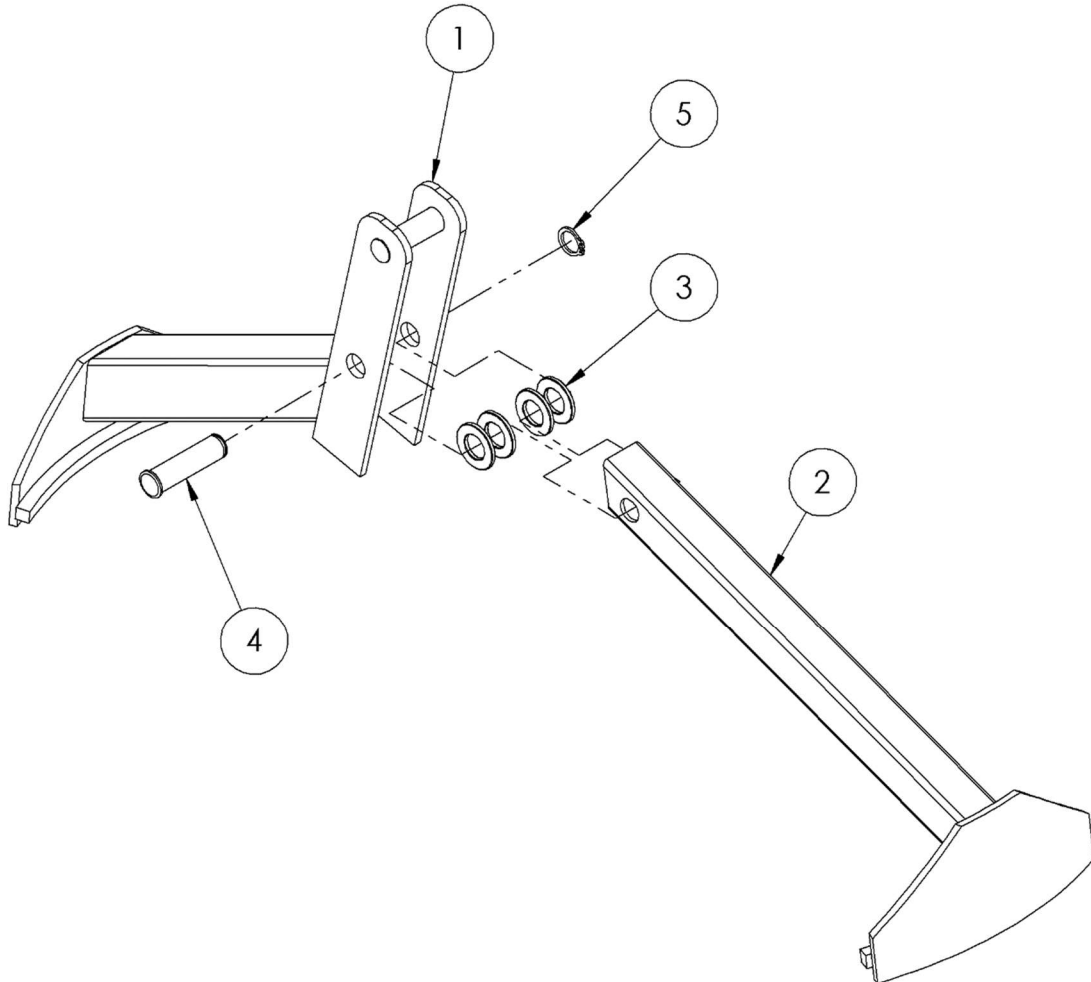

ITEM NO.	PART NUMBER	DESCRIPTION	QTY.
1	1335-P	FIXED ARM WELD, 91	1
2	1334-P	SWING ARM WELD, 91	1
3	55-P	WASHER, 3/4 SAE FL 1-1/2 OD	4
4	5585-P	PIN, GROOVE, 3/4 X 2.61	1
5	5330-P	SNAP RING, EXT, HD, .078, 3/4"	1

Model 91

Drum Lifter

SN 400000 to _____ or 0414 to _____ (MMYY)

