

CONTENTS

- Receiving Procedures
- Warranty
- Safety Information
- Machine Description
- Accessories
- START-UP Procedure
- Operating Instructions
- Maintenance

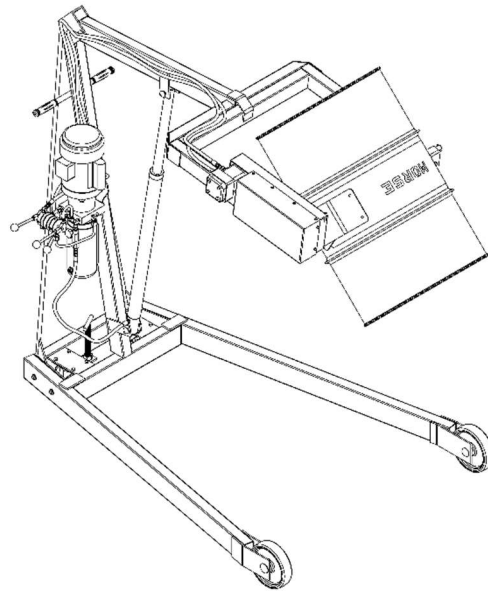

Receiving Procedures

Every Morse drum handler is inspected prior to shipping. However, damage may be incurred during transit.

- Check for visible damage. If you choose to accept damaged freight, always sign noting the damage on the **BILL OF LADING**.
- Document the damage and have the truck driver sign. We recommend keeping a digital camera at your receiving dock for this purpose.
- Open packages expeditiously to check the condition of the goods. There is only a 24 hour window to notify the carrier of any concealed damage.
- **IMMEDIATELY REPORT ALL DAMAGE TO THE SHIPPING COMPANY!** Then you may contact Morse for assistance with your freight claim.
- Morse Manufacturing will not be held responsible for any damaged freight that is not signed for as damaged.

Delivery to non-business addresses without a loading dock result in additional freight charges. Residential delivery fees, inside delivery fees, re-delivery charges, and lift gate services will be added by the truck line, and are non-negotiable.

Limited 2 Year Warranty

Morse drum handling equipment is guaranteed against defects in workmanship or materials for **TWO YEARS** when used properly within its rated capacity. Warranty does not cover wear from normal use or

damage from accident or abuse. Motors and other purchased parts carry the warranties of their manufacturers.

For warranty claims, contact your Morse Dealer to obtain a return authorization number, and for return freight advice. Return freight must be prepaid.

In all instances, liability is limited to the purchase price paid or to repairing or replacing the product. Customer assumes liability for any modifications, unauthorized repairs or parts substitution.

Safety Information

While Morse Manufacturing Co. drum handling equipment is engineered for safety and efficiency, a high degree of responsibility must be placed upon the machine operator to follow safe practices, based primarily on common sense, upon which true safety depends.

Failure to follow the safety precautions in this manual can result in personal injury or property damage. Observe the same precautions as with similar machinery where carelessness in operating or maintenance is hazardous to personnel. Carefully read the safety precautions below and throughout this manual.











DANGER - Indicates a situation which, if not avoided, will result in serious injury or death. This signal word is limited to the most extreme situations.



WARNING - Indicates a situation which, if not avoided, could result in serious injury or death.



CAUTION - Indicates a situation which, if not avoided, can result in damage to the machine.

 	<p>CAUTION – Do Not Transport with Drum Raised - ALWAYS LOWER THE DRUM HOLDER TO LOWEST POSITION BEFORE TRANSPORTING. The unit can become unstable when transporting with a raised load.</p>
	<p>DANGER - Stay Clear of Power Lines - KEEP WELL CLEAR OF POWER LINES. Never approach a power line. Current in a high voltage line may arc some distance from the wire to the steel framed, grounded machine.</p>
	<p>WARNING - The Hydra-Lift Karrier is designed to handle one drum of the types listed in Machine Description. DO NOT attempt to handle any other type of drum or object. DO NOT exceed the weight capacity of 800 Lb. (363 kg).</p>
	<p>WARNING - Level Floors Only - For operation only on clean, level floors of suitable bearing capacity. Do not use on sloped surfaces, ramps, irregular or debris strewn floors.</p>
	<p>WARNING - Do Not Modify the Unit - Under no circumstances should any modifications be made to the Morse machinery without factory authorization. Any modifications may void the warranty. This machine was designed to perform a specific job and alterations may result in injury to operator or machine.</p>
	<p>WARNING - No Loose Fitting Clothing - Wear close-fitting clothing and safety equipment appropriate to the job. Loose fitting clothing may become caught on the machinery and cause severe personal injury.</p>
	<p>WARNING - Hydraulic Fluid Under Pressure Can Be Hazardous - Escaping hydraulic fluid under pressure can penetrate the skin, causing serious injury. Avoid the hazard by relieving pressure before disconnecting hydraulic lines. Keep hands and body away from pinholes and nozzles, which eject fluid under high pressure. Use a piece of cardboard to search for leaks. If an accident occurs, see a doctor immediately and inform them of the nature of the accident.</p>
	<p>CAUTION - Wear Safety Shoes - Wear safety shoes with non-slip soles and hard toe protection.</p>
	<p>WARNING - This product can expose you to chemicals including barium sulfate, cobalt, titanium dioxide, and 2-methylimidazole, which are known to the State of California to cause cancer, and bisphenol-A, which is known to the State of California to cause birth defects or other reproductive harm. For more information go to www.P65Warnings.ca.gov</p>

Machine Description

Model 400A-96-117 Hydra-Lift Karrier will pour a drum up to 96" (244 cm) high, measured from the floor to the lowest point of a horizontal drum. It is designed to lift, transport, and dispense a 55-gallon (210 liter) steel or fiber drum 22" to 23.5" (56 to 59.7 cm) in diameter.

Maximum full-drum capacity is 800 Lb. (363 kg). Capacity is derated to 500 Lb. (227 kg) for a half-full drum. Half-full rating is based on the tilt mechanism's capacity for handling an unbalanced bottom-heavy drum.



Accessories

55/30 Series Diameter Adapters for drum with diameter smaller than 22" (56 cm). To handle a smaller drum, insert the correct size Diameter Adapter into the standard drum holder. See Diameter Adapter info at: <https://morsedrum.com/products/diameter-adapters>

All Diameter Adapters for drum with 17.5" (44.5 cm) diameter or smaller have integrated brackets to prevent drum slipping length-ways.

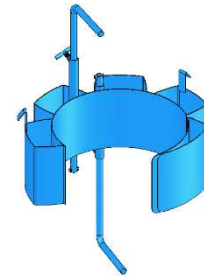

NOTE: To prevent 30-gallon (114 Liter) PLASTIC drum from slipping install ONE of the following

1. Diameter Adapter 55/30-19B which has integrated brackets
2. Diameter 55/30-19 **AND** Bracket 4556-P or Top Rim Clamp 4560B-P

IMPORTANT: To prevent a PLASTIC 30 to 55 gallon (114 to 210 Liter) size drum from slipping, you **MUST** install either Top Rim Clamp Kit or Bracket Assembly Kit.



Top Rim Clamp Kit # 4560B-P

Handle RIMMED plastic drum.

Install the Top Rim Clamp Kit to handle a RIMMED plastic, steel or fiber drum with suitable top rim.

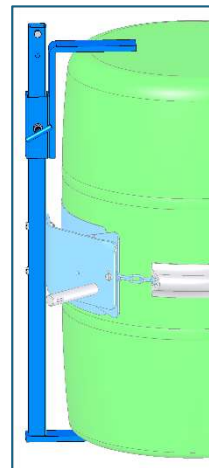

Bracket Assembly Kit # 4556-P

Required to handle RIMLESS plastic drum. Also recommended for fiber drum.

Bracket adjusts for 31" to 39" (79 to 99 cm) tall drum.

You can also handle a rimmed drum with Bracket installed.

Motor Information

Motor is dual voltage and can be wired for 1-phase 110V 50Hz or 1-phase 220V 50Hz. Motor does NOT come with switch, cord or plug. Consult an electrician to install and wire according to local codes.

Controls

The Morse Hydra-Lift Karrier is manually propelled and steered.

There are two functions for the operator to control.

1. **"LIFT"** and lower function for vertical positioning of the drum
To raise the drum
 - a. Plug motor into power supply.
 - b. Turn motor on by holding the momentary switch in the on position.
 - c. With motor on, raise the LIFT handle.To lower the drum
 - a. With the motor off, push in the LOWER handle.
2. **"TILT"** function to control the degree of rotation of the drum
To tilt the drum forward for pouring
 - a. Turn on motor by holding momentary switch in on position.
 - b. With motor on, raise tilt handle.To return the drum to vertical position
 - a. Turn on the motor by holding momentary switch in the on position.
 - b. Push the tilt handle down.

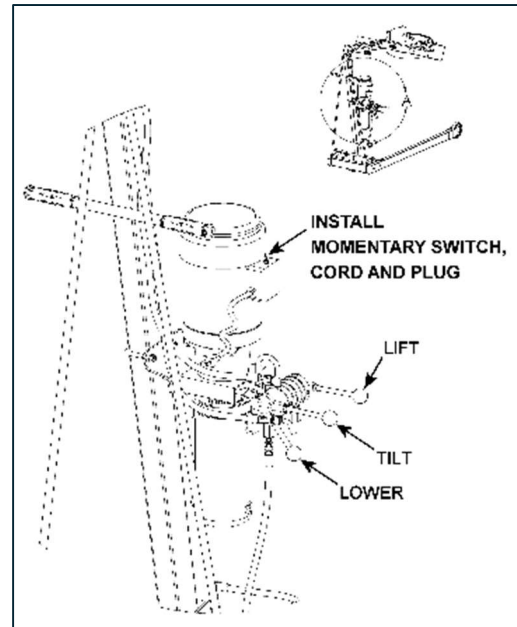

WARNING - Watch Out for Pinch Points.

Stay clear of moving parts. Operator should remain behind the push handle during the lift operation.

Floor Lock

The step-down floor lock is located behind the base. To activate, step down on the floor lock until it locks in down position. When floor lock is activated it prevents unwanted free wheeling of unit. Floor conditions determine effectiveness of floor lock. Operator should verify its holding action before depending on it to hold.

Drum Holder (Saddle) Assembly

The MORCINCH™ Drum Holder (Saddle) assembly is the component intended to hold drum. It is designed to secure a standard ribbed 55-gallon (210 liter) steel drum around its middle using cinch chain and ratchet tightening system. It automatically adjusts for 22" to 23.5" (56 to 59.7 cm) diameter drum.

The MORCINCH™ Drum Holder also accepts accessories to handle plastic drum, fiber drum, or smaller diameter drum.

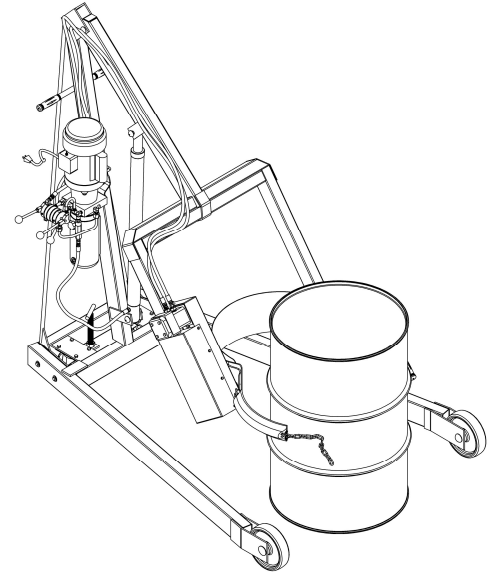

START-UP Procedure

Machine is shipped with hydraulic fluid.

- Install provided hydraulic control levers (threaded rods with black ball handles).
- **IMPORTANT:** BEFORE operation, remove the **RED** shipping plug from the hydraulic reservoir, and replace with the provided **BLACK** breather.

Operating Instructions

1. Push the Hydra-Lift Karrier to drum.
2. Using the "LIFT" control as described in "Machine Description - Controls", position drum holder assembly with back band at the middle of drum. With ratchet plate swung open and cinch chain hanging from chain hook, push unit until back band rests firmly against drum. Some adjustment to tilt angle of saddle (drum holder) may be necessary to ensure band fits flush on drum.
3. Attaching the drum:
 Drape chain across front of drum and engage chain link into notch in ratchet. Turn ratchet clockwise to tighten chain. If ratchet turns until pawl is beyond last ratchet tooth, turn ratchet back and slide next link into ratchet notch and try tightening again. Chain must be held tightly against drum with pawl engaged securely in ratchet teeth.
4. Operate lift function to lift drum clear of floor. Roll to dispensing location. **NOTE:** Do not allow drum to impact on floor, pouring station, etc. or spill or damage could occur.

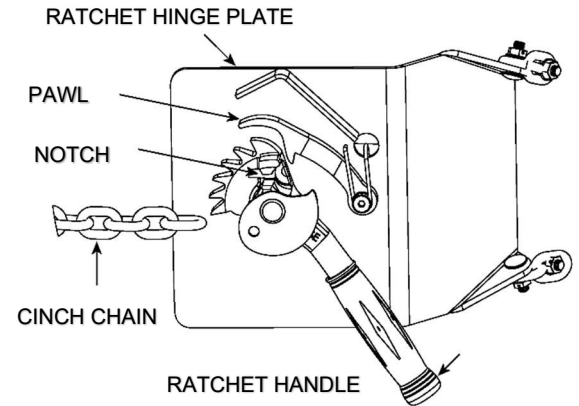

CAUTION – Do Not Transport with Drum Raised.

ALWAYS LOWER THE DRUM HOLDER TO LOWEST POSITION BEFORE TRANSPORTING.

The unit can become unstable when transporting with a raised load.

5. Lift drum to desired pouring height. Operate the tilt control as described in "Machine Description - Controls" to adjust drum attitude. This is especially important when lifting an open drum. Floor lock should be engaged while dispensing / draining.
6. When dispensing is complete, tilt drum back to upright position. Disengage floor lock and lower drum to transporting height; about 6" (15.2 cm) off the floor.



WARNING - Stay Clear of Raised Drum. NEVER allow anyone to be below any part of raised drum handler or drum. Remain behind push handle while handling a drum.



WARNING – Do NOT Disengage the Cinch Chain When Drum is off the Ground. When drum is in upright position, lower drum to floor before releasing cinch chain.

7. Push unit to drum storage area and lower drum to floor in upright position. Release cinch chain from ratchet by applying pressure to ratchet handle in clockwise direction with one hand and opening pawl to free ratchet with other hand. Remove cinch chain link from ratchet.

Maintenance

- Periodic inspection for general condition of structural and mechanical components is imperative for safe and efficient operation.
- Periodically inspect all moving parts, framework, and contact areas for signs of wear, fatigue, or loosening. Tighten, adjust, or replace parts as necessary to prevent failure and maintain proper function.
- Inspect hydraulic system for oil drips, hose damage, or other signs of wear. Inspect the level and condition of the hydraulic fluid. Replace any parts that show signs of wear.
- Grease wheel bearings periodically. Oil or grease all moving parts including: the three clevis pins and the surfaces of the boom which contact the inside of the mast cap, the hinge pin, the gears and sprockets in the tilt drive, and the ratchet and pawl.
- Worn or damaged parts must be properly replaced with the correct, genuine Morse parts.
- Hydraulic pump is shipped filled with Noco Premium plus automatic transmission fluid d/m. Safety Data Sheet (SDS / MSDS) is available online. Change oil yearly, sooner depending on dirty conditions or outdoor use. Replace oil with Mobil dte 24 or equivalent for indoor use (Mobil dte 13 for outdoor use).