

**CONTENTS**

	Page
Receiving Procedures. . . . .	1
Warranty. . . . .	1
Safety Information. . . . .	1 - 2
Machine Description. . . . .	3 - 5
Installation Instructions. . . . .	5
Operating Instructions. . . . .	6
Maintenance. . . . .	6

**Operator’s Manual**  
for Morse < PILOT > Power-Propelled  
Drum Pouter with Scale

**Model 905**  
Serial Number 417867 to \_\_\_\_\_

**Receiving Procedures**

Every Morse drum handler is inspected prior to shipping. However, damage may be incurred during transit.

- Check for visible damage. If you choose to accept damaged freight, always sign noting the damage on the **Bill of Lading**.
- Document the damage and have the truck driver sign. We recommend keeping a digital camera at your receiving dock for this purpose.
- Open packages expeditiously to check the condition of the goods. There is only a 24 hour window to notify the carrier of any concealed damage.
- Immediately **report all damage to the shipping company!** Then you may contact Morse for assistance with your freight claim.
- Morse Manufacturing will not be held responsible for any damaged freight that is not signed for as damaged.

**Limited 2 Year Warranty**

Morse drum handling equipment is guaranteed against defects in workmanship or materials for two years when used properly within its rated capacity. Warranty does not cover wear from normal use or damage from accident or abuse. Motors and other purchased parts carry the warranties of their manufacturers.

For warranty claims, contact your Morse Dealer to obtain a return authorization number, and for return freight advice. Return freight must be prepaid.

In all instances, liability is limited to the purchase price paid or to repairing or replacing the product. Customer assumes liability for any modifications, unauthorized repairs or parts substitution.

**Safety Information**

While Morse Manufacturing Co. drum handling equipment is engineered for safety and efficiency, a high degree of responsibility must be placed upon the machine operator to follow safe practices, based primarily on common sense, upon which true safety depends.

Failure to follow the safety precautions in this manual can result in personal injury or property damage. Observe the same precautions as with similar machinery where carelessness in operating or maintenance is hazardous to personnel. Carefully read the safety precautions below and throughout this manual.

Review the Material Safety Data Sheet(s) for the material(s) in the drum(s) and take all necessary precautions. Safety shoes, work gloves, hard hat and other personal protective devices are recommended.

Prior to initial use, inspect all moving parts and test rotation of drum holder. Perform necessary load test, inspections, operator training, etc.



[morsedrum.com](http://morsedrum.com)



[service@morsedrum.com](mailto:service@morsedrum.com)



(315) 437-8475





103 Kuhn Rd.  
Syracuse, NY, 13208 U.S.A.











**Operator's Manual for Morse < PILOT > Power-Propelled Drum Pouter with Scale  
Model 905 Serial Number 417867 to \_\_\_\_\_**

**Safety Information** (continued)

 **DANGER** - Indicates a situation which, if not avoided, *will* result in serious injury or death. This signal word is limited to the most extreme situations.

 **WARNING** - Indicates a situation which, if not avoided, *could* result in serious injury or death.

 **CAUTION** - Indicates a situation which, if not avoided, can result in damage to the machine.

-   **CAUTION - Do NOT transport with drum raised.**  
Always lower the drum holder to lowest position before transporting.
-  **DANGER - Stay well clear of power lines.**  
Never approach a power line. Current in a high voltage line may arc some distance from the wire to the steel framed, grounded machine.
-  **WARNING** - The < PILOT > Power-Propelled Drum Pouter is designed to handle one drum of the types listed at the top of page 3 - Machine Description. DO NOT attempt to handle any other type of drum or object. DO NOT exceed the weight capacity.
-  **WARNING - Level floors only.**  
For operation only on clean, level floors of suitable bearing capacity. Do not use on sloped surfaces, ramps, irregular or debris strewn floors.
-  **WARNING - Do NOT modify the unit.**  
Under no circumstances should any modifications be made to the Morse machinery without factory authorization. Any modifications may void the warranty. This machine was designed to perform a specific job and alterations may result in injury to operator or machine.
-  **WARNING - No loose fitting clothing.**  
Wear close-fitting clothing and safety equipment appropriate to the job. Loose fitting clothing may become caught on the machinery and cause severe personal injury.
-  **WARNING - Hydraulic fluid under pressure can be hazardous.**  
Escaping hydraulic fluid under pressure can penetrate the skin, causing serious injury. Avoid the hazard by relieving pressure before disconnecting hydraulic lines. Keep hands and body away from pinholes and nozzles, which eject fluid under high pressure. Use a piece of cardboard to search for leaks. If an accident occurs, see a doctor immediately and inform them of the nature of the accident.
-  **CAUTION - Wear safety shoes.**  
Wear safety shoes with non-slip soles and hard toe protection.
-  **WARNING:** This product can expose you to chemicals including barium sulfate, cobalt, titanium dioxide, and 2-methylimidazole, which are known to the State of California to cause cancer, and bisphenol-A, which is known to the State of California to cause birth defects or other reproductive harm.  
For more information go to [www.P65Warnings.ca.gov](http://www.P65Warnings.ca.gov)
-  **WARNING:** This product can expose you to chemicals including lead and arsenic, which are known to the State of California to cause cancer and birth defects or other reproductive harm.  
For more information go to [www.P65Warnings.ca.gov](http://www.P65Warnings.ca.gov)

**Operator's Manual for Morse < PILOT > Power-Propelled Drum Pourer with Scale  
Model 905 Serial Number 417867 to \_\_\_\_\_**

**Machine Description**

The Model 905 < PILOT > Power-Propelled Drum Pourer with Scale will pour a drum at up to 10.5' (3.2 m) high, measured from the floor to the lowest point of a horizontal drum. It is designed to lift, transport, and dispense a ribbed 55-gallon (210 liter) steel drum 22.5" (57 cm) in diameter, as well as a fiber drum between 22" and 23.5" (56 to 59.7 cm) in diameter.



The maximum full-drum capacity is 800 Lb. (363 kg) The capacity is derated to 500 Lb. (227 kg) for a half-full drum. The half-full rating is based on the tilt mechanism's capacity for handling an unbalanced bottom-heavy drum.

**Options**

- A smaller diameter drum can be handled with the correct size 55/30 Series Diameter Adaptor installed (see [Diameter Adaptor literature](#)).
- The **Bracket Assembly** (Part # 4556-P) is **required** to handle a plastic drum without a top rim (see figure 2.1). It is also recommended to more securely handle a fiber drum. You can use the Bracket Assembly with a 55-gallon (210 liter) plastic, steel or fiber drum. The brace at top and bottom of the drum prevent it from slipping lengthways through the drum holder. It adjusts for a drum 31" to 39" (79 to 99 cm) tall.
- The **Top Rim Clamp** (Part # 4560-P) grips the upper rim of your drum to prevent it from slipping through the drum holder (see figure 2.2). To handle a 55-gallon (210 liter) plastic drum with top rim, you **must** install either the Bracket Assembly or the Top Rim Clamp. You can use the Top Rim Clamp with a 55-gallon (210 liter) plastic, steel or fiber drum with suitable top rim.

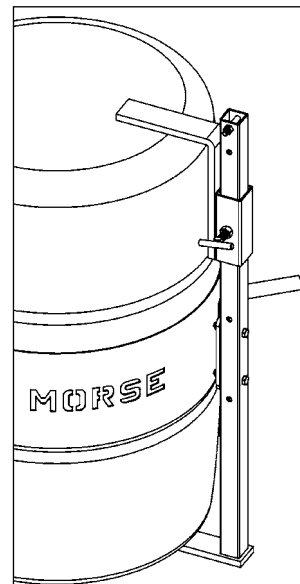

**Figure 2.1**  
Plastic drum being lifted with part number 4556-P Bracket Assembly installed.

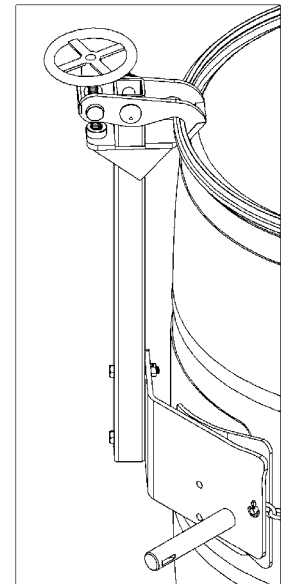

**Figure 2.2**  
Plastic drum being lifted with part number 4560-P Top Rim Clamp Assembly installed.

**Operator's Manual for Morse < PILOT > Power-Propelled Drum Pouter with Scale  
Model 905 Serial Number 417867 to \_\_\_\_\_**

**Controls**

**Steering Arm and Control Handle (Figure 4.1)**

The steering arm and control handle provide controls for steering, forward and reverse speed control, braking, and horn. The control handle has push buttons for raising and lowering the drum. Control handle also has a "belly-button" reversing switch which reverses the direction of the truck upon contact with the operator.

**Forward and Reverse Travel Speed Control (Figure 4.1)**

Forward and reverse are controlled by rotating the speed control lever. Further rotation in either direction will progress the truck from slow to maximum travel speed. The lever is spring loaded to return to neutral when released.

To reverse directions or to stop the truck, rotate the speed control lever in the opposite direction. The truck will come to a stop and then, unless the controls are returned to the center neutral position, accelerate in the opposite direction.

**Steering (Figure 4.1)**

Using the control handle to move the steering arm to left or right will turn the truck left or right. When maneuvering around corners, make square turns and be sure there is adequate clearance.

**Stopping (Figure 4.2)**

Stop the truck as gradually as possible. Unnecessary rapid stopping could be hazardous. Load could become unstable.

There are four possible ways to stop the truck:

1. **Plugging:** This electrical braking function consists of rotating the speed control lever in opposite direction of travel and then releasing it when the truck stops. Plugging is a convenient way to stop the truck during normal operation. If the control is not released, the truck will accelerate in the opposite direction.
2. **Steering arm in horizontal position:** Lowering the steering arm to the horizontal position applies the brakes. Lowering the steering arm below horizontal position increases the braking force and de-energizes the controls.
3. **Steering arm in vertical position:** Raising the steering arm to near vertical position applies the brakes. Further vertical positioning increases the braking force and de-energizes the controls. This position serves as a parking brake.
4. **Deadman braking:** As a safety precaution, the steering arm is spring loaded to return to the vertical position and apply the brakes if the driver releases the control handle during operation. This is known as deadman braking.

**Figure 4.1**

**Figure 4.2**

**Operator's Manual for Morse < PILOT > Power-Propelled Drum Pouter with Scale  
Model 905 Serial Number 417867 to \_\_\_\_\_**

**Lift / Lower and Tilt Control Levers (Figure 5.1)**

**Battery Disconnect (Figure 5.1)**

A battery disconnect is mounted near the rear of the battery compartment. Pulling the disconnect removes all power from truck circuits in the event of an emergency.

**Parking**

When parking the truck, do not obstruct traffic lanes or aisles.

1. Park the truck in its designated parking area.
2. Raise the steering arm until vertical to apply the parking brake.
3. Fully lower lift assembly.
4. Turn key to off position. Remove key for added security.
5. Pull out battery disconnect.

**Figure 5.1**

Also see [further information](#).



**WARNING - Watch out for pinch points**  
Stay clear of moving parts. Operator should remain behind the controls during the lift operation.

**Drum Holder Assembly**

The MORCINCH™ drum holder assembly (or “saddle assembly”) is the component on the < PILOT > Power-Propelled Drum Pouter that is intended to hold the drum. The carriage assembly moves vertically along the mast, to position the MORCINCH™ drum holder assembly designed to secure a drum around it's middle using a cinch chain and ratchet tightening system.

The MORCINCH™ drum holder accepts accessories for handling a plastic drum, a fiber drum, or a smaller diameter drum (see options on page 3).

**Operator's Manual for Morse < PILOT > Power-Propelled Drum Pourer with Scale**  
**Model 905 Serial Number 417867 to \_\_\_\_\_**

**Operating Instructions**

1. Maneuver the < PILOT > Power-Propelled Drum Pourer to the drum.
2. Using the "LIFT" control as described in "Machine Description - Controls" (page 4), position the drum holder assembly with the back band at the middle of the drum. With the ratchet plate swung open and the cinch chain hanging from the chain hook, push the unit until the back band rests firmly against the drum. Some adjustment to the tilt angle of the saddle may be necessary to ensure band fits flush on the drum.

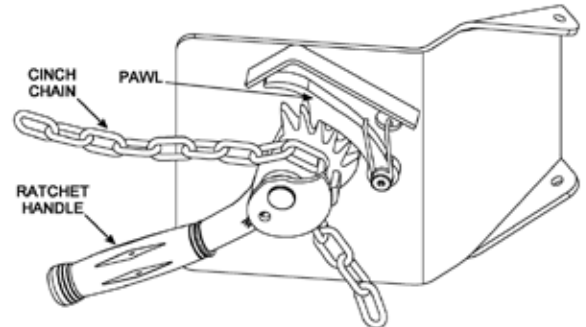

**Figure 3.2**

3. **Attaching the drum:** Drape the cinch chain across the front of the drum and engage a chain link into the slot in the ratchet (Figure 3.2). Turn the ratchet clockwise to tighten cinch chain. If ratchet turns until the pawl is beyond the last ratchet tooth, turn the ratchet back and slide the next link into the ratchet slot and try tightening again. The cinch chain must be held tightly against the drum with the pawl engaged securely in the ratchet teeth.

4. Operate the lift function to lift drum clear of floor. Move to dispensing location. NOTE: Do not allow the drum to impact on floor, pouring station, etc. or a spill or damage could occur.



**CAUTION – Do NOT transport with drum raised.**

ALWAYS LOWER THE DRUM HOLDER TO LOWEST POSITION BEFORE TRANSPORTING.  
The unit can become unstable when transporting with a raised load.

5. Lift drum to desired pouring height. Operate the tilt control as described in "Machine Description - Controls" (page 5) to adjust the drum attitude.
6. When dispensing is complete, tilt drum back to upright position. Lower the drum to transporting height; about 6" off the floor.



**WARNING - Stay clear of raised drum**

NEVER allow anyone to be below any part of a raised drum handler or drum. Remain behind the push handle while handling a drum.



**WARNING – Do NOT disengage the cinch chain when drum is off the ground.**

When the drum is in the upright position, lower the drum to the floor before releasing the cinch chain.

7. Move the unit to the drum storage area and lower to the floor in an upright position. Release the cinch chain from the ratchet by applying pressure to the ratchet handle in a clockwise direction with one hand and opening the pawl to free the ratchet with the other hand. Remove the cinch chain link from the ratchet.

Also see further [operating instructions](#).

**Maintenance**

1. Periodic inspection for the general condition of structural and mechanical components is imperative for safe and efficient operation.
2. Periodically inspect all moving parts, framework, drum holder and contact areas for signs of wear, fatigue, or loosening. Tighten, adjust, or replace parts as necessary to prevent failure and maintain proper function.
3. Inspect the hydraulic system for oil drips, hose damage, or other signs of wear. Replace any parts that show signs of wear.
4. Grease wheel bearings periodically. Oil or grease all moving parts, including: the gears and sprockets in the tilt drive, and the ratchet and pawl.
5. Worn or damaged parts must be properly replaced with the correct, genuine Morse parts.

Also see more detailed [maintenance instructions](#).