

CONTENTS

	Page
Receiving Procedures.	1
Warranty.	1
Safety Information.	1 - 2
Machine Description.	2
Maintenance.	2
Operating Instructions.	3
Parts Lists and Diagrams.	4

Operator’s Manual
for Morse Stainless Steel
Clamp+GO™ Dolly Handle
Model 24-SS

Serial Number 0612 to ____ (MMYY)

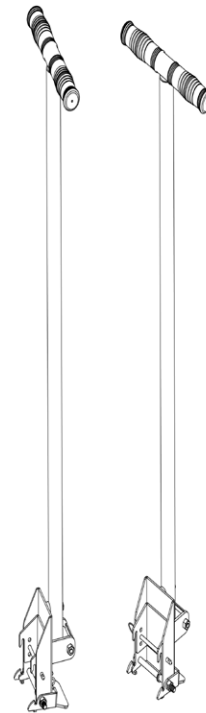

Receiving Procedures

Every Morse drum handler is inspected prior to shipping. However, damage may be incurred during transit.

- Check for visible damage. If you choose to accept damaged freight, always sign noting the damage on the **Bill of Lading**.
- Document the damage and have the truck driver sign. We recommend keeping a digital camera at your receiving dock for this purpose.
- Open packages expeditiously to check the condition of the goods. There is only a 24-SS hour window to notify the carrier of any concealed damage.
- Immediately **report all damage to the shipping company!** Then you may contact Morse for assistance with your freight claim.
- Morse Manufacturing will not be held responsible for any damaged freight that is not signed for as damaged.

Limited 2 Year Warranty

Morse drum handling equipment is guaranteed against defects in workmanship or materials for two years when used properly within its rated capacity. Warranty does not cover wear from normal use or damage from accident or abuse. Motors and other purchased parts carry the warranties of their manufacturers.

For warranty claims, contact your Morse Dealer to obtain a return authorization number, and for return freight advice. Return freight must be prepaid.

In all instances, liability is limited to the purchase price paid or to repairing or replacing the product. Customer assumes liability for any modifications, unauthorized repairs or parts substitution.

Safety Information

While Morse Manufacturing Co. drum handling equipment is engineered for safety and efficiency, a high degree of responsibility must be placed upon the machine operator to follow safe practices, based primarily on common sense, upon which true safety depends.

Failure to follow the safety precautions in this manual can result in personal injury or property damage. Observe the same precautions as with similar machinery where carelessness in operating or maintenance is hazardous to personnel. Carefully read the safety precautions below and throughout this manual.

Review the Material Safety Data Sheet(s) for the material(s) in the drum(s) and take all necessary precautions. Safety shoes, work gloves, hard hat and other personal protective devices are recommended.

Prior to initial use, inspect all moving parts and test rotation of chain wheel and saddle assembly. Inspect saddle assembly for proper operation. Perform necessary load test, inspections, operator training, etc.



morsedrum.com



service@morsedrum.com





(315) 437-8475



103 Kuhn Rd.
Syracuse, NY 13208 U.S.A.

Operator's Manual for Morse Stainless Steel Clamp+GO™ Dolly Handle Model 24-SS
Serial Number 0612 to ____ (MMYY)

Safety Information (continued)

	DANGER - Indicates a situation which, if not avoided, will result in serious injury or death. This signal word is limited to the most extreme situations.
	WARNING - Indicates a situation which, if not avoided, could result in serious injury or death.
	CAUTION - Indicates a situation which, if not avoided, can result in damage to the machine.



WARNING - Do Not Modify the Unit. Under no circumstances should any modifications be made to the Morse machinery without factory authorization. Any modifications may void the warranty. This machine was designed to perform a specific job and alterations may result in injury to operator or machine.



WARNING - No Loose Fitting Clothing. Wear close-fitting clothing and safety equipment appropriate to the job. Loose fitting clothing may become caught on the machinery and cause severe personal injury.



CAUTION - Wear safety shoes with non-slip soles and hard toe protection.



CAUTION: DO NOT allow drum to impact on floor, ground, or dumping station, etc.



WARNING: This product can expose you to chemicals including barium sulfate, cobalt, titanium dioxide, and 2-methylimidazole, which are known to the State of California to cause cancer, and bisphenol-A, which is known to the State of California to cause birth defects or other reproductive harm.
For more information go to www.P65Warnings.ca.gov

Machine Description

The **Clamp+GO™** Dolly Handle is designed to transport a drum dolly with sidewall 2", 2.5" or 3" tall. Comply with the maximum capacity of the drum dolly being handled.

Important

1. Review the Material Safety Data Sheet(s) for the material(s) in the drum(s) and take all necessary precautions. Safety shoes, work gloves, hard hat and other personal protective devices are recommended.
2. When loading, unloading, operating, or maintaining your MORSE drum handler, always use care and good judgment. Maintain secure footing and a firm hold. Keep hands and loose clothing away from all moving parts. Never allow anyone to be below any part of a raised drum handler or drum. Read operating instructions and review the pictures in the sales brochure before operation.
3. Prior to initial use, inspect all moving parts and test rotation of chain wheel and saddle assembly. Inspect saddle assembly for proper operation. Perform necessary load test, inspections, operator training, etc.

Maintenance

Properly lube moving parts.

- Quick Pin for adjusting to height of drum dolly sidewall

**Operator's Manual for Morse Stainless Steel Clamp+GO™ Dolly Handle Model 24-SS
Serial Number 0612 to ____ (MMYY)**

Operating Instructions (non-stainless model 24 shown)

To Set Clamp+GO™ for Height of Drum Dolly Sidewall

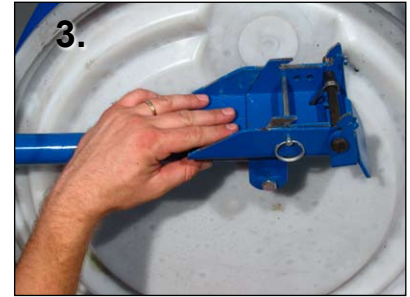
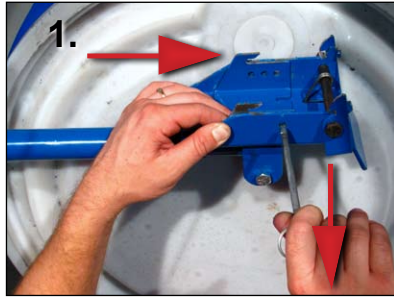

1. First, remove Quick Pin. Then slide inner piece to align with appropriate hole, positioning Top Jaw for the sidewall height of your dolly.
2. Insert Quick Pin through hole in outer housing, holes in inner piece, and hole on opposite side on outer housing.
- 1st Hole (above) for 2" (5.08 cm) tall dolly sidewall
- 2nd Hole for 2.5" (6.35 cm) tall dolly sidewall
- 3rd Hole (picture #1) for 3" (7.62 cm) tall dolly sidewall

To Attach Clamp+GO™ to Drum Dolly

1. With the clamp assembly in the free swinging mode (not attached to magnet), position the top claws over the top edge of the dolly rim. Note: You may use your steel-toe boot to help guide the Clamp+GO into position to align the top claws.
2. Secure the clamp to your dolly by using a quick downward push on the handle. You will hear the bottom jaw click into place.
3. Carefully pull handle to verify proper connection before moving the dolly.
4. For convenient storage, push the Clamp+GO™ handle to upright position, and a magnet holds it in place.

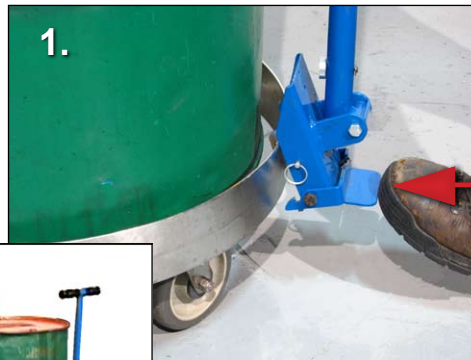

To Remove Clamp+GO™ from Drum Dolly

1. While holding the handle, use your steel-toe boot to lift the bottom jaw paddle to release the bottom jaw from the dolly.
2. Pull up on Clamp+GO™ handle to move away from the drum dolly

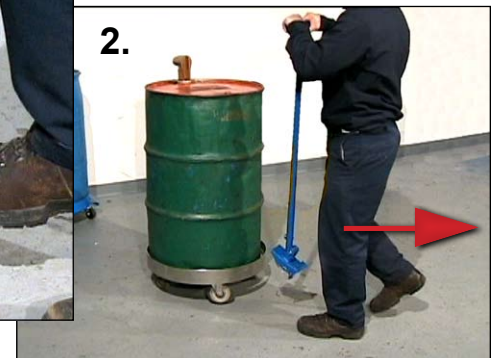

Operator's Manual for Morse Stainless Steel **Clamp+GO**™ Dolly Handle Model 24-SS
Serial Number 0612 to ____ (MMYY)

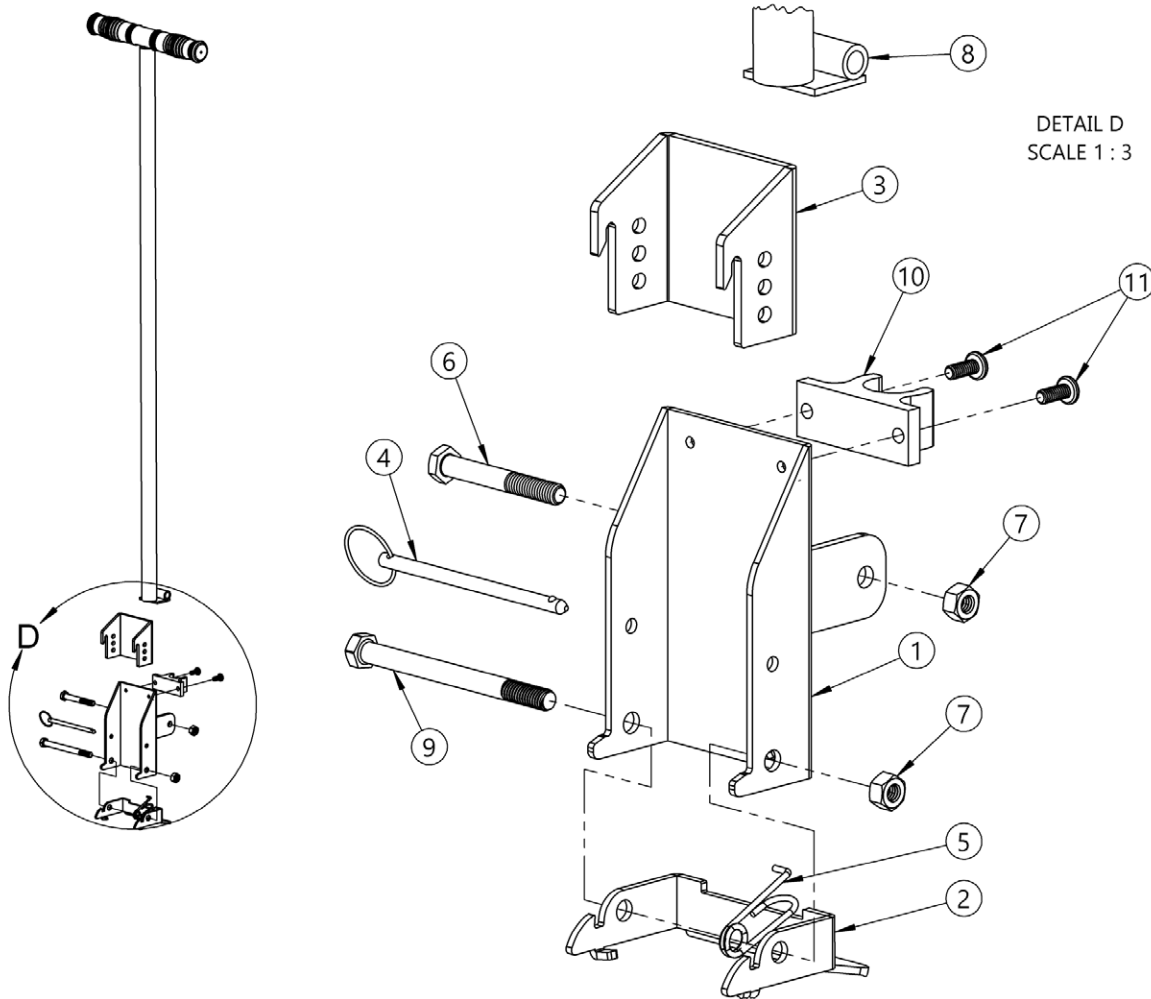

ITEM NO.	PART NUMBER	DESCRIPTION	QTY.
1	4714SS-P	HOUSING WELD, 24-SS	1
2	4716SS-P	TOE RELEASE, 24-SS	1
3	4713SS-P	JAW, TOP, 24-SS	1
4	4666SS-P	PIN, QUICK, 1/4 X 4.0" SS	1
5	169SS-P	SPRING, PAWL, SS	1
6	1315SS-P	HHCS, 3/8-16 X 2-3/4 GR2 SS	1
7	3981SS-P	NUT, 3/8-16 NYLON LOCK, SS	2
8	5047SS-P	HANDLE ASM, 24-SS	1
9	4890SS-P	HHCS, 3/8-16 X 4-1/2 SS	1
10	5200-P	CLIP, PIPE HANDLE, 24-SS	1
11	1517SS-P	SCREW, 1/4-20 X 5/8 PAN HD, SS	2